

**Ex d Start Enclosure
300830552**

**PRODUCT DATA SHEET:
PDS 7137 Issue 2**

PYROBAN®

DESCRIPTION



Part 300830552 is a certified enclosure that incorporates equipment to isolate, terminate and suitably fuse specific types of Pyroban Starter Motors and Battery.

This enclosure is designed to be used in conjunction with the Pyroban Starter Motor part numbers 300825183 (24VDC) Product Data Sheet PDS 7117 & 300826738 (24VDC) Product Data Sheet PDS 7124

This enclosure is designed to be used in conjunction with the Pyroban Battery part number 300810374/S (12VDC) only. 2x batteries required for a 24V supply. Product data Sheet PDS 7081

Enclosure material: Aluminium EN485. Ingress protection rating: IP65

For restrictions see 'LIMITATIONS' and 'CERTIFICATION' sections later in this document.

THIS EQUIPMENT MUST BE INSTALLED AND MAINTAINED IN ACCORDANCE WITH IEC 60079-14 AND 17. FAILURE TO OBSERVE ANY INSTRUCTIONS IN THIS DATA SHEET MAY INVALIDATE ANY WARRANTY AGREEMENT.



INSTALLATION

- Mounting limitations
- Do not mount the enclosure where it will be subjected to severe vibration or shock.
- An equipotential bonding point is fitted on the outside of the enclosure. This must be connected according to IEC 60079-0.

CERTIFICATION

Part Number	300830552
Type of Protection	Ex d
Marking Code	Ex II 2G Ex d IIB T6 Gb
Gas Group	IIB
Ambient Temperature	-20°C to +55°C
Certificate Number	SEV17ATEX0116X IECEX SEV17.0005X
Environmental Protection	IP65

Marking (Actual Label)

	V: 24 VDC A: 500 A MAX RATING: - V: - A: - RATING: - USE CABLE SUITABLE FOR 70 °C WARNING: DO NOT OPEN WHEN ENERGISED WARNING: DO NOT OPEN WHEN AN EXPLOSIVE ATMOSPHERE IS PRESENT
TYPE C0502 ○  II 2G Ex d IIB T6 Gb IP65 Tamb -20°C to +55°C PART No: 300830552 SERIAL No: CERT NUMBER: SEV17ATEX0116X IECEXSEV17.0005X	Pyroban Ltd, Shoreham-by-Sea, BN43 6QG, England www.pyroban.com

Serial number format:

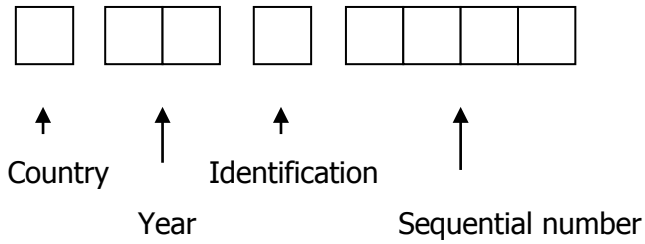

For example:

C17E0093 would indicate-

C for Pyroban UK Ltd

17 for year of manufacture 2017

E to identify an enclosure

0093 is the sequential number

LIMITATIONS

This enclosure is designed to be used in conjunction with Pyroban Starter Motor part numbers:

1. 300825183 (24VDC) Product data Sheet PDS 7117
2. 300826738 (24VDC) Product data Sheet PDS 7124

This enclosure is designed to be used in conjunction with the Pyroban Battery part number 300810374/S (12VDC) only. 2x batteries required for a 24V supply. Product data Sheet PDS 7124

Do not pressure wash the enclosure.

The enclosure must be de-energised before opening.

Only use glands suitable for the cable.

Install glands according to IEC 60079-14.

Do not add un-approved components inside the enclosure as this will void warranty and certification.

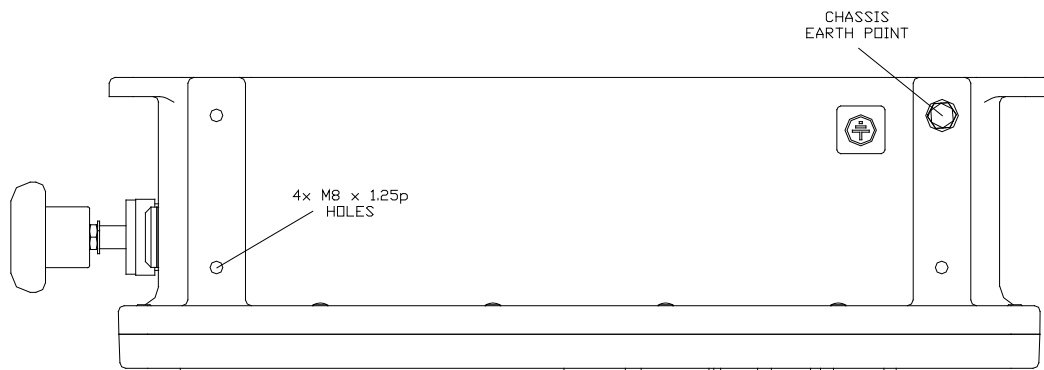
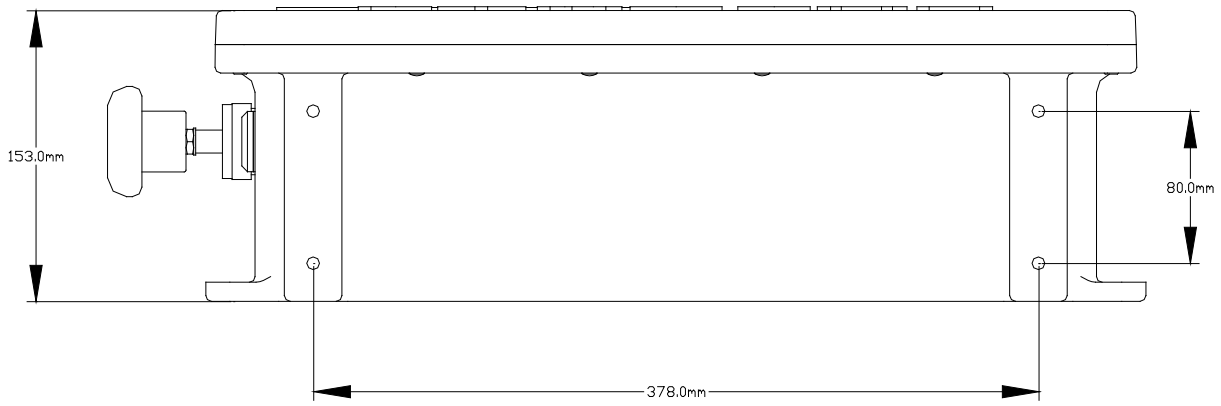
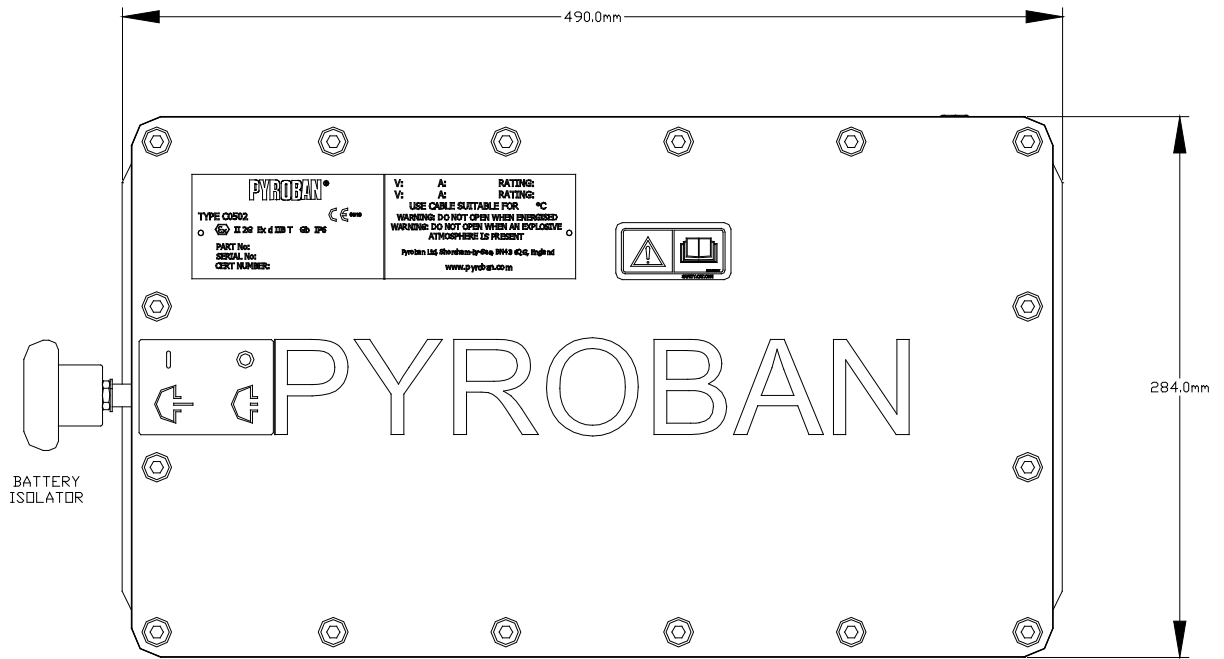
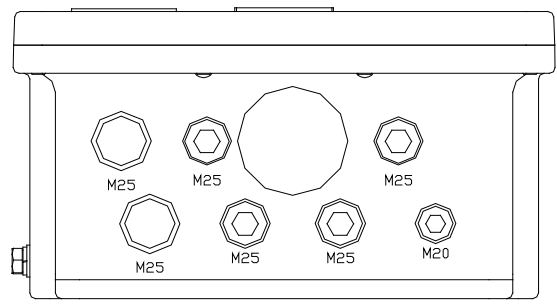
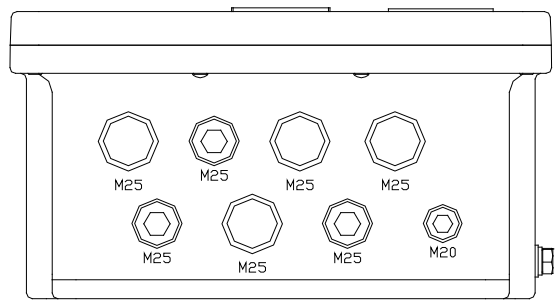
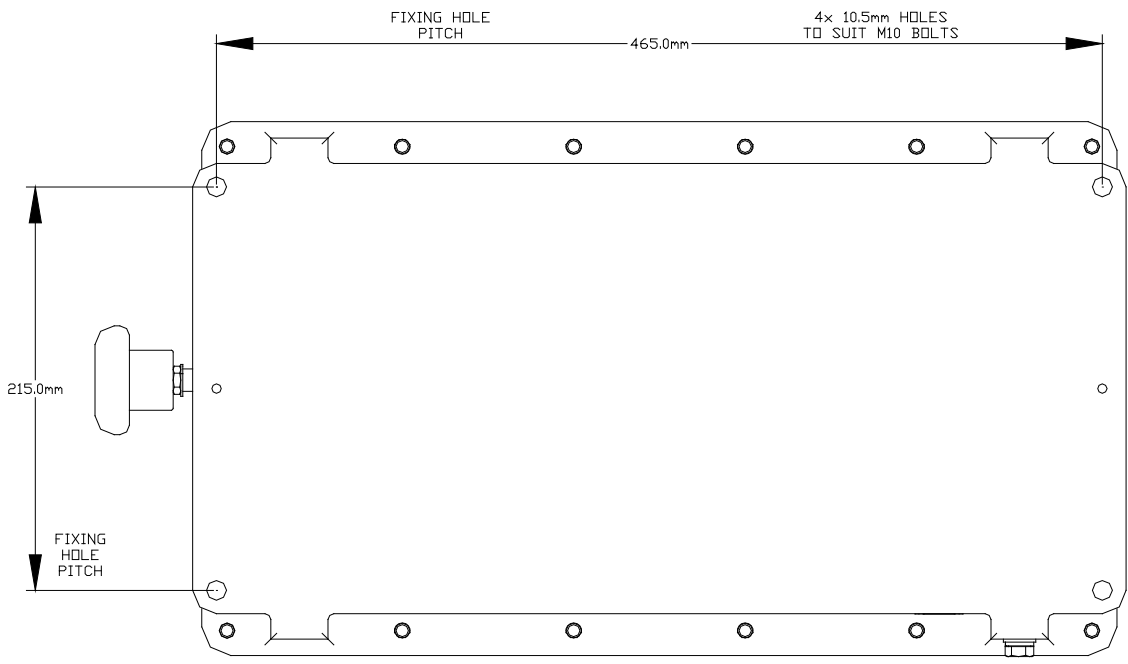

Diagram 1: Enclosure details



GLAND HOLES = 13x M25, 2x M20
GLANDS ARE NOT SUPPLIED.

Diagram 2: Enclosure details (ctd)

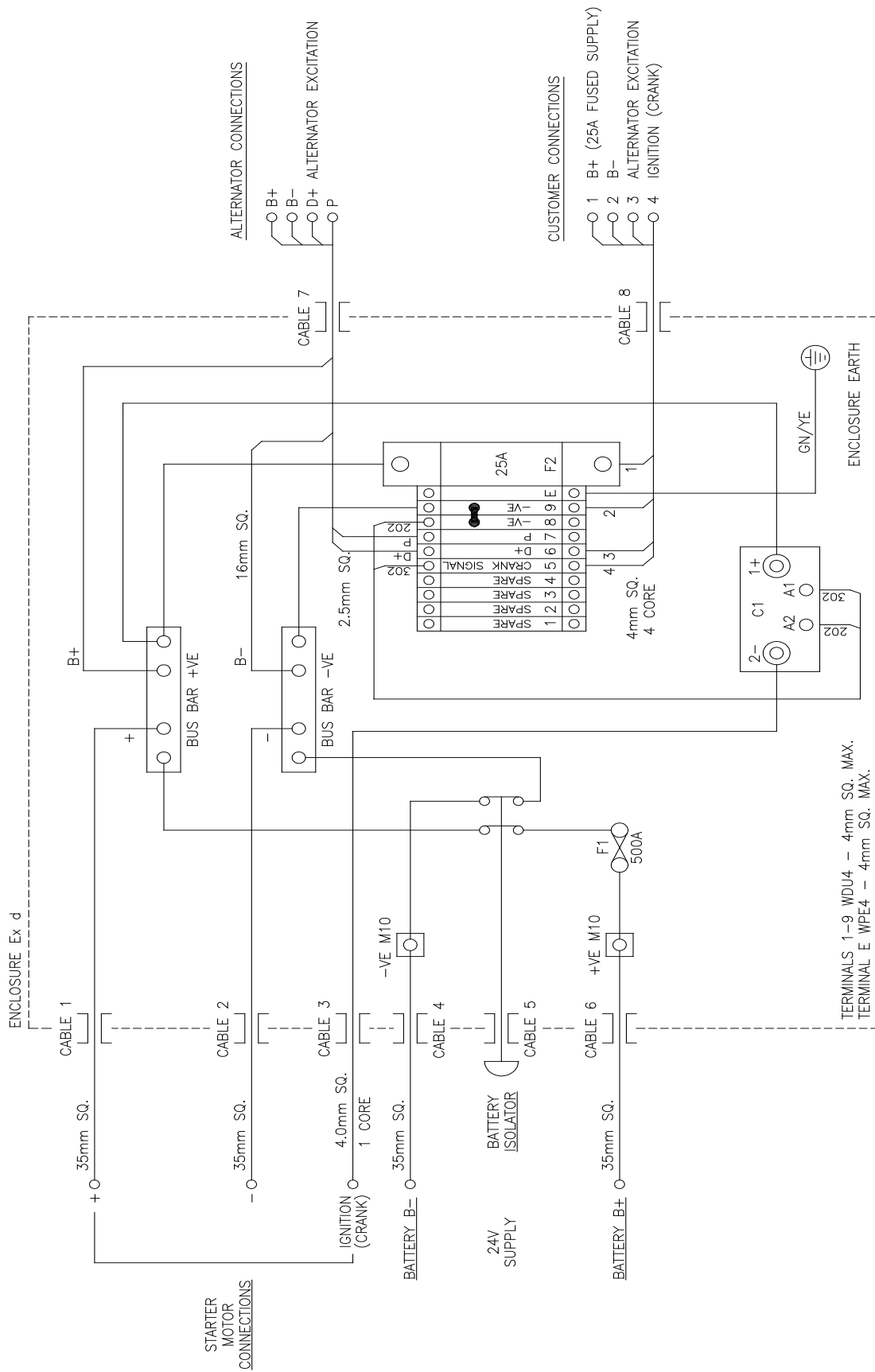

Diagram 3: Wiring diagram

Maintenance to be carried out in a safe area.

Monthly

- Recommended visual inspection as detailed in IEC 60079-17.

Annually

- Close and detailed inspection as detailed in IEC 60079-17.
- Inspect the unit for damage both internal and external, check conductors for damage. Check tightness of terminal screws. Check equipotential bonding.
- Check tightness of lid retaining bolts.
- If defects found contact Pyroban Customer services for advice.

REPLACEMENT

Please quote the Pyroban part number 300830552 for unit replacement.

Isolate the electrical supply before attempting any electrical work.

DECLARATION OF CONFORMITY

We, Pyroban Limited, Dolphin Road, Shoreham-by Sea, Sussex, BN43 6QG, UK, declare that the component mentioned in this data sheet has been designed and manufactured in accordance with the essential health and safety requirements of Directive 2014/34/EU (ATEX) inclusive of subsequent amendments. Compliance with these Directives is established by meeting the technical requirements of the relevant CEN and CENELEC standards.



Dario Bussandri

NPI and Engineering Manager

OTHER INFORMATION

Nothing contained in this brochure is intended to extend any warranty or representation, expressed or implied, regarding the products described herein. Any such warranties or other terms and conditions of sale of products shall be in accordance with Pyroban's standard terms and conditions of sale for such products, which are available upon request. Specifications and machinery may be altered without notice at any time.

CONTACTS

Pyroban Limited
Dolphin Road
Shoreham-by-Sea
West Sussex BN43 6QG
United Kingdom

Telephone:
+44 (0) 1273 456800
Email: customerservice@pyroban.com

www.pyroban.com